

pst-pad

A PSTricks package for drawing attachment models

ver. 0.3c

Patrick Drechsler*

August 19, 2008

'pst-pad' is a PSTricks package to draw simple attachment systems.

Contents			
		3.5.2 FluidShearOffsetY	5
		3.6 Tilting parameters	5
1 Introduction	1	4 Example Usage	5
2 Parameters	2	5 Low-level Macros	6
3 High-level Macros (“Objects”)	3	5.1 PstWall	6
3.1 PstWallToWall	3	5.2 PstFluid	6
3.2 PstSphereToWall	3	5.3 PstSphere	7
3.3 PstPad	3	5.4 PstFlattenedSphere	7
3.4 Basic Usage	4	6 TODO	7
3.5 Liquid shearing	4	7 Acknowledgements	7
3.5.1 FluidShearOffsetX	4		

1 Introduction

The package 'pst-pad' is a collection of graphical elements based on PSTricks that can be used to facilitate display of attachment systems such as two differently shaped surfaces with or without a fluid wedged in between. These macros ease the display of wet adhesion models and common friction systems such as boundary lubrication, elastohydrodynamic lubrication and hydrodynamic lubrication. The name 'pst-pad' was chosen because I used this package to display models of different animal attachment pads in my research.

*<patrick.drechsler@pstricks.de>

2 Parameters

There are specific parameters defined to easily change the behaviour of the pst-pad objects you are drawing.

fluid (boolean): (*default: true*)
WallThickness (dimension): (*default: 1*)
WallString (string): (*default:*)
WallAngle (PSTricks color): (*default: 0*)
WallLineWidth (dimension): (*default: 1pt*)
WallLineColor (PSTricks color): (*default: black*)
SphereStartAngle (dimension): (*default: 180*)
SphereEndAngle (boolean): (*default: 360*)
SphereRadius (dimension): (*default: 1*)
ShpereString (string): (*default:*)
SphereOffset (dimension): (*default: 0*)
SphereFillColor (PSTricks color): (*default: white*)
SphereLineWidth (dimension): (*default: 1pt*)
SphereLineColor (PSTricks color): (*default: black*)
FSphereHeight (dimension): (*default: 2*)
FSphereFillColor (PSTricks color): (*default: lightgray*)
FSphereString (string): (*default:*)
FSphereLineWidth (dimension): (*default: 1pt*)
FSphereLineColor (PSTricks color): (*default: black*)
FluidMaxRadius (dimension): (*default: 1*)
FluidMinRadius (dimension): (*default: .5*)
FluidHeight (dimension): (*default: .5*)
FluidFillColor (PSTricks color): (*default: yellow*)
FluidString (string): (*default:*)
FluidShearOffsetX (dimension): (*default: 0*)
FluidShearOffsetY (dimension): (*default: 0*)
FluidLineWidth (dimension): (*default: 1pt*)
FluidLineColor (PSTricks color): (*default: black*)
StringA (string): (*default:*)
StringB (string): (*default:*)
TotalAngle (angle): (*default: 0*)

3 High-level Macros (“Objects”)

There are three high-level macros: `PstWallToWall`, `PstSphereToWall` and `PstPad`.

3.1 `PstWallToWall`

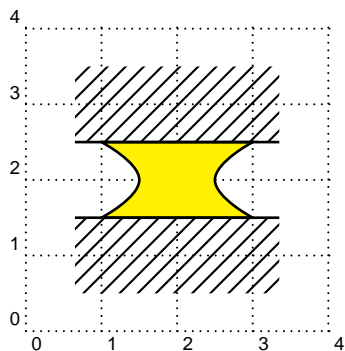

```

1 \begin{pspicture}(4,4)\psgrid
2   \PstWallToWall(2,2)
3 \end{pspicture}

```

3.2 `PstSphereToWall`

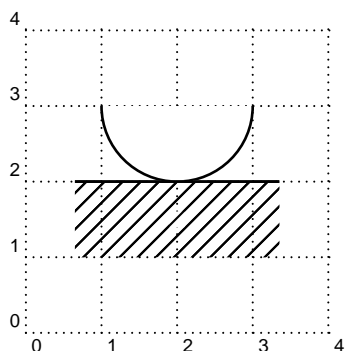

```

1 \begin{pspicture}(4,4)\psgrid
2   \PstSphereToWall[fluid=false](2,2)
3 \end{pspicture}

```

3.3 `PstPad`

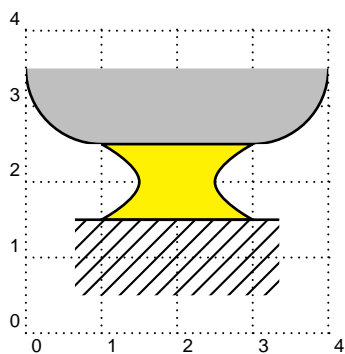

```

1 \begin{pspicture}(4,4)\psgrid
2   \PstPad(2,2)
3 \end{pspicture}

```

3.4 Basic Usage

The following figure shows the usage of some basic parameters with the PstPad macro. Green and brown colored values in parentheses give default and example values, respectively.

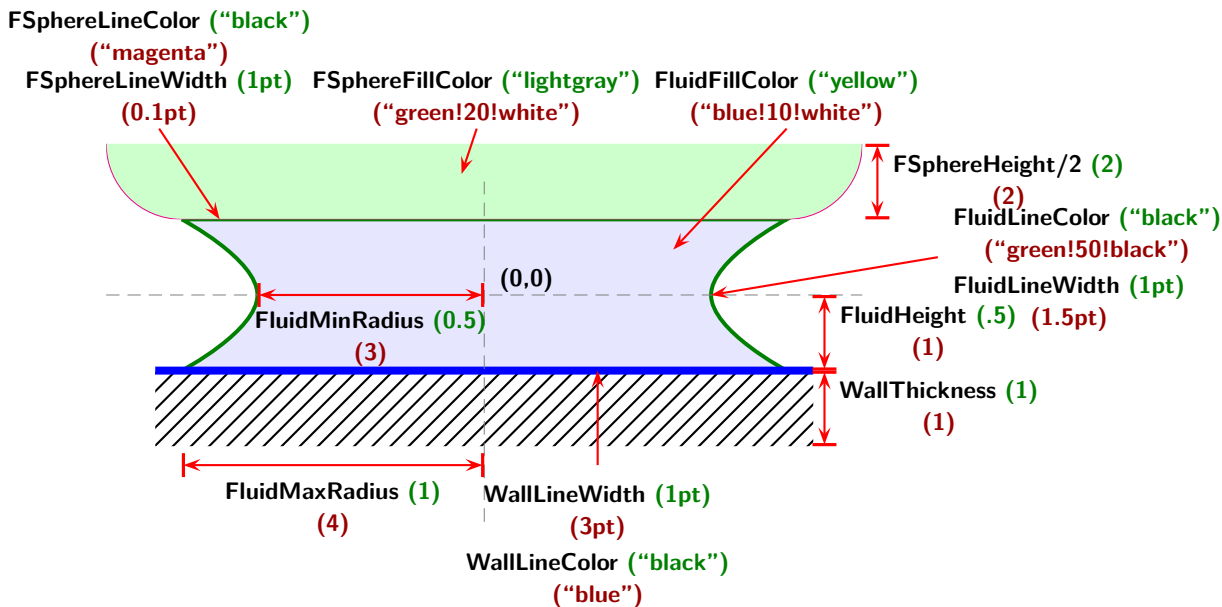

3.5 Liquid shearing

Sheared liquids sandwiched between two surfaces can also be displayed. The following figures shows the usage of the parameters FluidShearOffsetX and FluidShearOffsetY. Again, green and brown colored values in parentheses give default and example values, respectively.

3.5.1 Parameter FluidShearOffsetX

FluidShearOffsetX describes the x offset from the current value of FluidMaxRadius.

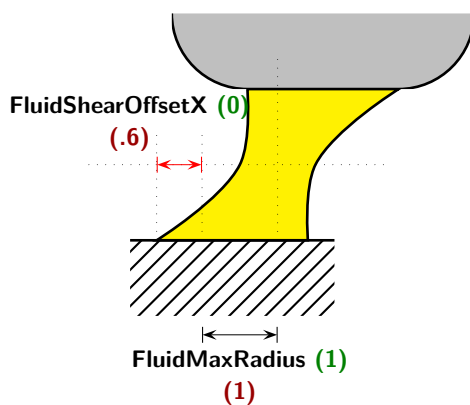

3.5.2 Parameter FluidShearOffsetY

FluidShearOffsetY describes the y offset from zero to determine the curvature of the meniscus.

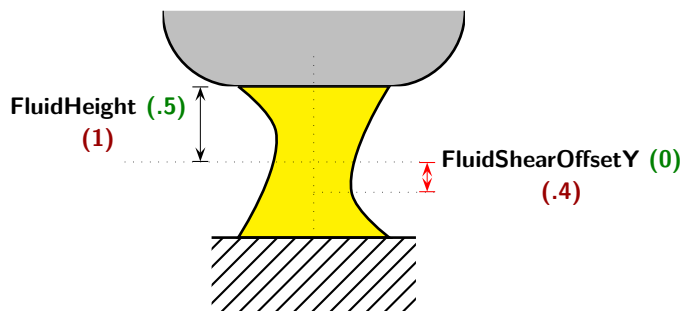

3.6 Tilting parameters

The following figure shows the usage of the TotalAngle parameter. The default angle is 0 degrees. Again, green and brown colored values in parentheses give default and example values, respectively.

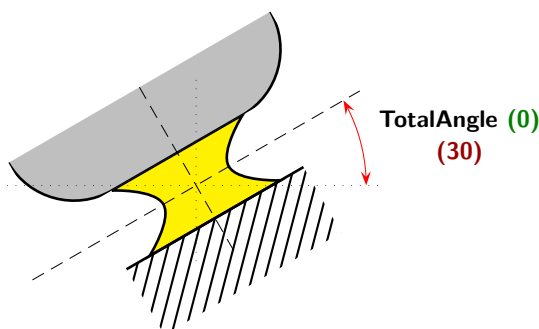

4 Example Usage

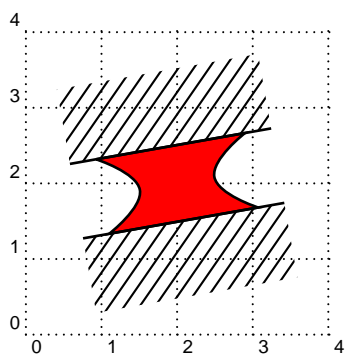

```

1 \begin{pspicture}(4,4)\psgrid
2   \PstWallToWall[%
3   FluidFillColor=red,%
4   TotalAngle=10%
5   ](2,2)
6 \end{pspicture}

```

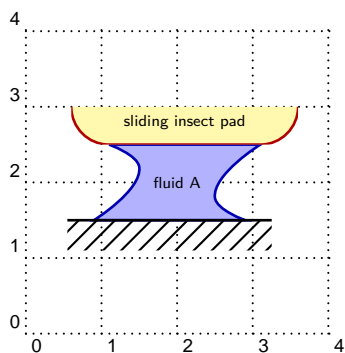

```

1 \begin{pspicture}(4,4)\psgrid
2 \tiny\sffamily%
3 \PstPad[%
4 FluidFillColor=blue!30!white,%
5 FluidLineColor=blue!70!black,%
6 FSphereFillColor=yellow!40!white,%
7 FSphereLineColor=red!70!black,%
8 FluidString={fluid A},%
9 FluidShearOffsetX=0.1,%
10 FluidShearOffsetY=0.2,%
11 WallThickness=0.4,%
12 FSphereHeight=1,%
13 StringA={sliding insect pad}%
14 ](2,2)
15 \end{pspicture}

```

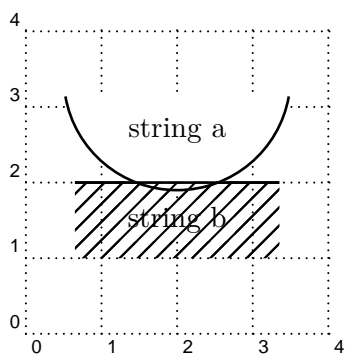

```

1 \begin{pspicture}(4,4)\psgrid
2 \PstSphereToWall[%
3 fluid=false,%
4 SphereRadius=1.5,%
5 SphereStartAngle=190,%
6 SphereEndAngle=350,%
7 SphereOffset=0.1,%
8 StringA={string a},%
9 StringB={string b}%
10 ](2,2)
11 \end{pspicture}

```

5 Low-level Macros

There are four low-level macros: `PstWall`, `PstFluid`, `PstSphere` and `PstFlattenedSphere`.

5.1 PstWall

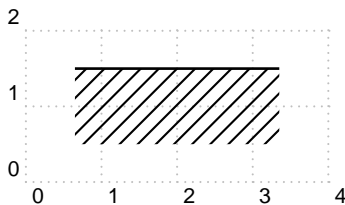

```

1 \begin{pspicture}[showgrid=true](4,2)
2 \PstWall(2,1.5)
3 \end{pspicture}

```

5.2 PstFluid

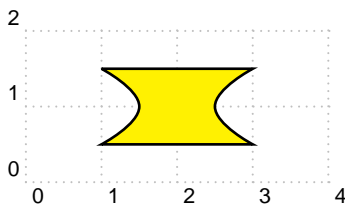

```

1 \begin{pspicture}[showgrid=true](4,2)
2 \rput(2,1){\PstFluid[unit=1pt](0,0)}
3 \end{pspicture}

```

5.3 PstSphere

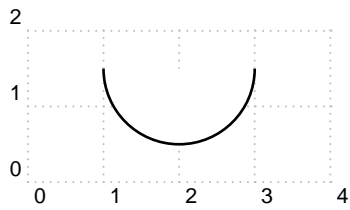

```
1 \begin{pspicture}[showgrid=true](4,2)  
2   \PstSphere(2,.5)  
3 \end{pspicture}
```

5.4 PstFlattenedSphere

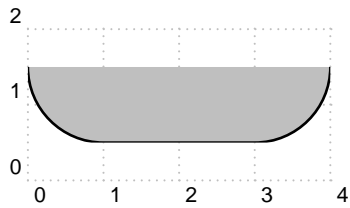

```
1 \begin{pspicture}[showgrid=true](4,2)  
2   \PstFlattenedSphere(2,.5)  
3 \end{pspicture}
```

6 TODO

- Enhance calculations and number conversions.
- Implement different degrees of surface roughness.
- Implement fluid film contact angle parameter.

7 Acknowledgements

I would like to thank Herbert Voß and Alan Ristow for their help on getting me started with PSTricks macros and low-level calculations in PostScript and T_EX.